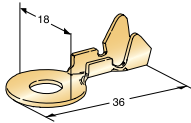
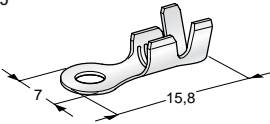
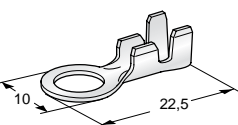
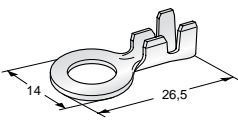
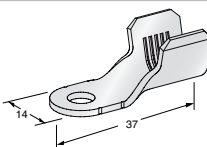
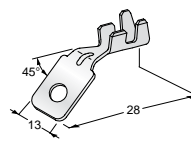
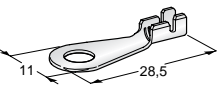
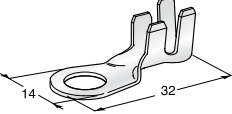
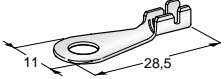
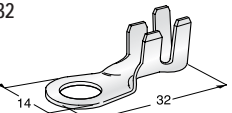
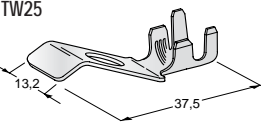
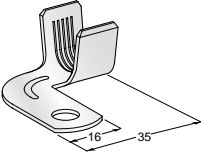
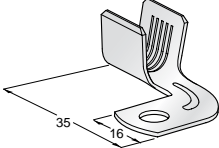
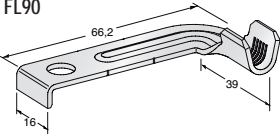
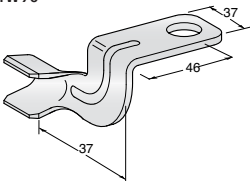

TERMINAL

Terminals
Cosses
Kabelschuhe

DISEGNO DRAWING DESSIN ZEICHNUNG	SEZIONE CAVO CABLE SECTION SECTION DU CÂBLE KABEL QUERSCHNITT mm ²	SPESSORE THICKNESS ÉPAISSEUR DICKE mm	VITE SCREW VIS SCHRAUBE	MATERIALE MATERIAL MATÉRIEL WERKSTOFF	REF.		PCS	MASTER PCS
					SCATOLA BOX BOÎTE SCHACHTEL	BOBINA REEL BOBINE SPULE		
UNI 679 L35 	4÷6	0.7	M10	CuZn	16.02550	-	100	-
STD L15 	0.5÷2	0.5	M2	CuZn-Sn	-	17.02951	8000	-
	0.5÷2	0.5	M3	CuZn-Sn	-	17.02950	8000	-
STD L22 	1÷2	0.6	M4	CuZn	16.02970	-	100	-
				CuZn	19.02970	-	5000	-
				CuZn-Sn	-	17.02970	5000	-
	1÷2	0.6	M5	CuZn	16.02980	-	100	-
				CuZn	19.02980	-	5000	-
				CuZn-Sn	-	17.02980	5000	-
	1÷2	0.6	M6	CuZn	16.02981	-	100	-
				CuZn	19.02981	-	5000	-
				CuZn-Sn	-	17.02981	5000	-
STD L26 	2÷2.5	0.8	M6	CuZn	16.02990	-	100	-
	2÷4	0.8	M8	CuZn	16.03000	-	100	-
STD L37 	25÷40	1.5	M6	CuZn-Sn	16.09000	-	3000	-
GND188 G45 	2.5÷6	0.8	M5	CuZn-Sn	-	17.08160	1200	4800
GND L28 	0.5÷1.5	0.6	M5	CuZn-Sn	16.06740	-	100	-
				CuZn-Sn	-	17.06740	4000	-

DISEGNO DRAWING DESSIN ZEICHNUNG	SEZIONE CAVO CABLE SECTION SECTION DU CÂBLE KABEL QUERSCHNITT mm ²	SPESSORE THICKNESS ÉPAISSEUR DICKE mm	VITE SCREW VIS SCHRAUBE	MATERIALE MATERIAL MATÉRIEL WERKSTOFF	REF.		PCS	MASTER PCS
					SCATOLA BOX BOÎTE SCHACHTEL	BOBINA REEL BOBINE SPULE		
GND L32 	1÷2.5	0.8	M6 M6	CuZn-Sn CuZn-Sn	11.06720 -	- 17.06720	100 2000	- -
	4÷6	0.8	M6 M6	CuZn-Sn CuZn-Sn	11.06700 -	- 17.06700	100 1500	- -
	8÷10	0.8	M6 M6	CuZn-Sn CuZn-Sn	11.06750 -	- 17.06750	100 1000	- -
	1÷2.5	0.8	M8 M8	CuZn-Sn CuZn-Sn	11.06730 -	- 17.06730	100 2000	- -
	4÷6	0.8	M8 M8	CuZn-Sn CuZn-Sn	11.06710 -	- 17.06710	100 1500	- -
	8÷10	0.8	M8 M8	CuZn-Sn CuZn-Sn	11.06760 -	- 17.06760	100 1000	- -
GND F L28 	0.5÷1.5	0.6	M5	CuZn-Sn	-	17.06741	4000	-
GND F L32 	1÷2.5	0.8	M6	CuZn-Sn	-	17.06721	2000	-
	3÷6	0.8	M6	CuZn-Sn	-	17.06701	2000	-
	1÷2.5	0.8	M8	CuZn-Sn	-	17.06731	2000	-
	3÷6	0.8	M8	CuZn-Sn	-	17.06711	2000	-
GND188 TW25 	2.5÷4	0.8	M8	CuZn-Sn	-	17.08150	1200	4800

DISEGNO DRAWING DESSIN ZEICHNUNG	SEZIONE CAVO CABLE SECTION SECTION DU CÂBLE KABEL QUERSCHNITT mm ²	SPESSORE THICKNESS ÉPAISSEUR DICKE mm	VITE SCREW VIS SCHRAUBE	MATERIALE MATERIAL MATÉRIEL WERKSTOFF	REF.		PCS	MASTER PCS
					SCATOLA BOX BOÎTE SCHACHTEL	BOBINA REEL BOBINE SPULE		
CBA FL90 	10÷20	1.5	M8	CuZn-Sn	16.08170 -	- 17.08170	500 500	- 2000
					NEW			
	25÷35	1.5	M6	CuZn-Sn	16.04300	-	1500	-
	25÷35	1.5	M8	CuZn-Sn	16.08210 -	- 17.08210	1500 400	- 1600
	50÷70	1.8	M8	CuZn-Sn	-	17.08230	300	1200
CBASX FL90 	20÷35	1.8	M6	CuZn-Sn	-	17.08325	350	1400
						NEW		
	25÷35	1.8	M8	CuZn-Sn	-	17.08320	350	1400
	20÷40	1.8	M8	CuZn-Sn	16.08321	-	1000	-
					NEW			
	50÷70	1.8	M6	CuZn-Sn	-	17.08315	300	1200
	50÷70	1.8	M8	CuZn-Sn	-	17.08310	300	1200
						NEW		
CBAJ81 FL90 	10÷20	1.5	M8	Cu-Sn	16.09200	-	500	-
FLANGE TW90 	10÷20	1.5	M8	CuZn-Sn	16.08600	-	1500	-
	25÷35	1.5	M8	CuZn-Sn	16.08700	-	1500	-

DISEGNO DRAWING DESSIN ZEICHNUNG	SEZIONE CAVO CABLE SECTION SECTION DU CÂBLE KABEL QUERSCHNITT mm ²	SPESSORE THICKNESS ÉPAISSEUR DICKE mm	VITE SCREW VIS SCHRAUBE	MATERIALE MATERIAL MATÉRIEL WERKSTOFF	REF.		PCS	MASTER PCS
					SCATOLA BOX BOÎTE SCHACHTEL	BOBINA REEL BOBINE SPULE		
MEGA G90 	10÷20	1.5	M8	Cu-Sn	16.08180	-	2000	-
	25÷35	1.5	M8	Cu-Sn	16.08190	-	2000	-
MEGA L34 	10÷20	1.2	M8	Cu-Sn	11.08110 -	- 17.08110	10 450	-
	25÷35	1.2	M8	Cu-Sn	11.08120 -	- 17.08120	10 350	-
MEGA L41 	25÷40	1.5	M8	Cu-Sn	16.08196	-	1000	-
PTC G90 	2.5÷4	0.8	M8	Cu-Sn	16.08500	-	2000	-
MIDI L27 	2.5÷4	0.8	M5	CuZn-Sn	11.08240 -	- 17.08240	10 1000	- 4000
	6÷8	0.8	M5	CuZn-Sn	11.08245 -	- 17.08245	10 800	- 3200
	6÷8	0.8	M6	CuZn-Sn	-	17.08246	800	3200
MIDI L30 	10÷16	0.8	M5	CuZn-Sn	-	17.08250	800	3200
MIDI L33 POL.C 	10÷20	1.5	M5	Cu-Sn	-	17.05835	500	2000

DISEGNO DRAWING DESSIN ZEICHNUNG	SEZIONE CAVO CABLE SECTION SECTION DU CÂBLE KABEL QUERSCHNITT mm ²	SPESSORE THICKNESS ÉPAISSEUR DICKE mm	VITE SCREW VIS SCHRAUBE	MATERIALE MATERIAL MATÉRIEL WERKSTOFF	REF.		PCS	MASTER PCS
					SCATOLA BOX BOÎTE SCHACHTEL	BOBINA REEL BOBINE SPULE		
MIDI L33 POL.A 	2.5÷4	0.8	M5	Cu-Sn	-	17.05616	1000	4000
						NEW		
MIDI L33 POL.B 	6÷8	0.8	M5	Cu-Sn	-	17.05725	1000	4000
MIDI L33 POL.D NEW 	6÷8	0.8	M5	Cu-Sn	-	17.05745	1000	4000
MIDI G90 UNI 	2.5÷4	0.8	M5	Cu-Sn	16.05600	-	2000	-
	6÷8	0.8	M5	Cu-Sn	16.05700	-	2000	-
MIDI G90 UNI 	10÷16	1.5	M5	Cu-Sn	16.05800	-	2000	-
	25÷35	1.5	M5	Cu-Sn	16.05900	-	2000	-
MIDI G90 POL.A 	2.5÷4	0.8	M5	Cu-Sn	16.05610	-	2000	-
	6÷8	0.8	M5	Cu-Sn	16.05710	-	2000	-
MIDI G90 POL.A 	10÷16	1.5	M5	Cu-Sn	16.05810	-	2000	-
	25÷35	1.5	M5	Cu-Sn	16.05910	-	2000	-

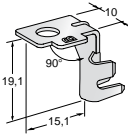
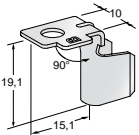
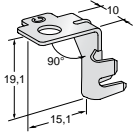
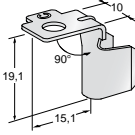
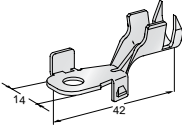
DISEGNO DRAWING DESSIN ZEICHNUNG	SEZIONE CAVO CABLE SECTION SECTION DU CÂBLE KABEL QUERSCHNITT mm ²	SPESSORE THICKNESS ÉPAISSEUR DICKE mm	VITE SCREW VIS SCHRAUBE	MATERIALE MATERIAL MATÉRIEL WERKSTOFF	REF.		PCS	MASTER PCS
					SCATOLA BOX BOÎTE SCHACHTEL	BOBINA REEL BOBINE SPULE		
MIDI G90 POL.B 	2.5÷4	0.8	M5	Cu-Sn	16.05620	-	2000	-
	6÷8	0.8	M5	Cu-Sn	16.05720	-	2000	-
MIDI G90 POL.B 	10÷16	1.5	M5	Cu-Sn	16.05820	-	2000	-
	25÷35	1.5	M5	Cu-Sn	16.05920	-	2000	-
MIDI G90 POL.C 	2.5÷4	0.8	M5	Cu-Sn	16.05630	-	2000	-
	6÷8	0.8	M5	Cu-Sn	16.05730	-	2000	-
MIDI G90 POL.C 	10÷16	1.5	M5	Cu-Sn	16.05830	-	2000	-
	25÷35	1.5	M5	Cu-Sn	16.05930	-	2000	-
RVS-A L42 	2.5÷4	0.8	M6	Cu-Sn	-	17.06900	750	3000
	6÷8	1.0	M6	Cu-Sn	-	17.06910	700	2800
	10÷16	1.2	M6	Cu-Sn	-	17.06920	600	2400

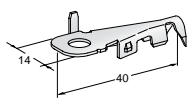
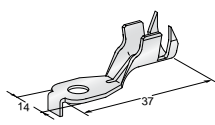
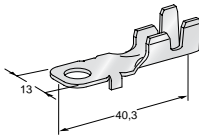
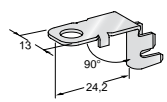
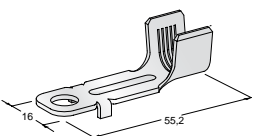
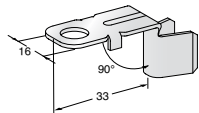
DISEGNO DRAWING DESSIN ZEICHNUNG	SEZIONE CAVO CABLE SECTION SECTION DU CÂBLE KABEL QUERSCHNITT mm ²	SPESSORE THICKNESS ÉPAISSEUR DICKE mm	VITE SCREW VIS SCHRAUBE	MATERIALE MATERIAL MATÉRIEL WERKSTOFF	REF.		PCS	MASTER PCS
					SCATOLA BOX BOÎTE SCHACHTEL	BOBINA REEL BOBINE SPULE		
RVS-B L40 	2.5÷4	0.8	M6	Cu-Sn	-	17.06930	1100	4400
	6÷8	1.0	M6	Cu-Sn	-	17.06940	1000	4000
SMT-A L39 	6÷8	1	M6	CuZn-Sn	-	17.06880	700	2800
	10÷16	1.2	M6	CuZn-Sn	16.06890 -	- 17.06890	2000 600	- 2400
SMT-B L40 	2.5÷4	0.8	M6	CuZn-Sn	16.06600 -	- 17.06600	2000 1500	- 6000
SMT-B G90 	2.5÷4	0.8	M6	CuZn-Sn	16.06790	-	2000	-
SMT-C L55 	50÷70	1.5	M8	CuZn-Sn	16.06796	-	1000	-
SMT-C G90 	6÷8	1.2	M6	CuZn-Sn	16.06775	-	500	-
	10÷20	1.2	M6	CuZn-Sn	16.06770	-	2000	-
	25÷40	1.2	M6	CuZn-Sn	16.06500	-	2000	-
	10÷20	1.2	M8	CuZn-Sn	16.06780	-	2000	-
	25÷40	1.2	M8	CuZn-Sn	16.06785	-	2000	-

DISEGNO DRAWING DESSIN ZEICHNUNG	SEZIONE CAVO CABLE SECTION SECTION DU CÂBLE KABEL QUERSCHNITT mm ²	SPESSORE THICKNESS ÉPAISSEUR DICKE mm	VITE SCREW VIS SCHRAUBE	MATERIALE MATERIEL WERKSTOFF	REF.		PCS	MASTER PCS
					SCATOLA BOX BOÎTE SCHACHEL	BOBINA REEL BOBINE SPULE		
SMT-C G90 	50÷70	1.5	M8	CuZn-Sn	16.06795	-	1000	-
SQR-A 	10÷20	1.2	M6	CuZn-Sn	-	17.06970	600	2400
	25÷35	1.2	M6	CuZn-Sn	-	17.06980	500	2000
	25÷40	1.5	M6	CuZn-Sn	16.06981	-	1800	-
	10÷20	1.2	M8	CuZn-Sn	-	17.06950	600	2400
	25÷35	1.2	M8	CuZn-Sn	-	17.06960	500	2000
	25÷40	1.5	M8	CuZn-Sn	16.06990	-	2000	-
SQR-A G40 	25÷40	1.2	M6	CuZn-Sn	16.06982	-	2000	-
SQR-B L46 	10÷20	1.5	M10	CuZn-Sn	-	17.08220	500	1500
	25÷35	1.5	M10	CuZn-Sn	-	17.08200	400	1200
SQR-C L45DX 	10÷20	1.5	M10	CuZn-Sn	-	17.08185	500	1500
	25÷40	1.5	M10	CuZn-Sn	-	17.08260	500	1500

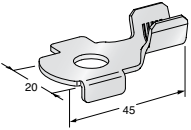
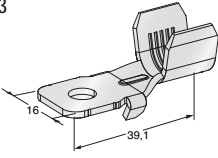
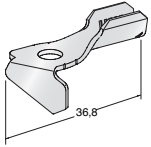
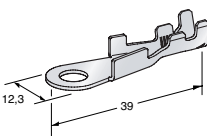
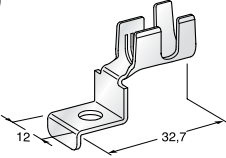
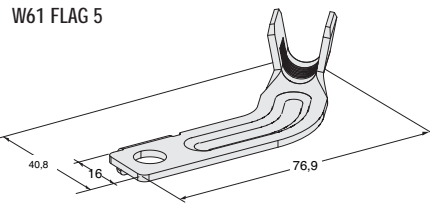
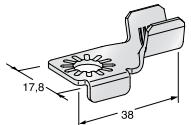
DISEGNO DRAWING DESSIN ZEICHNUNG	SEZIONE CAVO CABLE SECTION SECTION DU CÂBLE KABEL QUERSCHNITT mm ²	SPESSORE THICKNESS ÉPAISSEUR DICKE mm	VITE SCREW VIS SCHRAUBE	MATERIALE MATERIAL MATÉRIEL WERKSTOFF	REF.		PCS	MASTER PCS
					SCATOLA BOX BOÎTE SCHACHTEL	BOBINA REEL BOBINE SPULE		
SQR-C L45SX 	10÷20	1.5	M10	CuZn-Sn	-	17.08195	500	1500
	25÷40	1.5	M10	CuZn-Sn	-	17.08270	500	1500
SQR-C MY03 	10÷20	1.5	M6	CuZn-Sn	-	17.06975	600	2400
	25÷40	1.5	M6	CuZn-Sn	-	17.06977	500	2000
SQR-30 	6÷8	1.5	M6	CuZn-Sn	16.08340 -	- 17.08340	3000 600	- 2400
	10÷20	1.5	M6	CuZn-Sn	16.08345 -	- 17.08345	3000 500	- 2000
SEL-30 L39 	2.5÷5	0.8	M6	CuZn-Sn	-	17.08350	1500	-
HNDTW G90 	8÷15	1	M5	CuZn-Sn	16.07300	-	3000	-
W61 FLAG 5 	25 25+25	1.8	M8	CuZn-Sn	16.09600	-	500	-
W84 L38 	10÷25	1.5	M8	CuZn-Sn	16.08800	-	2000	-

NEW

NEW

NEW

DISEGNO DRAWING DESSIN ZEICHNUNG	SEZIONE CAVO CABLE SECTION SECTION DU CÂBLE KABEL QUERSCHNITT mm ²	SPESSORE THICKNESS ÉPAISSEUR DICKE mm	VITE SCREW VIS SCHRAUBE	MATERIALE MATERIAL MATÉRIEL WERKSTOFF	REF.		PCS	MASTER PCS
					SCATOLA BOX BOÎTE SCHACHETEL	BOBINA REEL BOBINE SPULE		
W84 G90 L41 	25÷41	1.5	M8	CuZn-Sn	16.08901	-	800	-
W84 TW90 L38 	10÷25	1.5	M8	Cu-Sn	16.08911	-	800	-
ND TW90 	25÷40	1.5	M8	CuZn-Sn	16.09100	-	1000	-
DADO G90 	2.5÷5	1.0	M5	CuZn-Sn	16.08400	-	3000	-
DADO G90 SH 	2.5÷5	1.2	M5	CuZn-Sn	16.08420	-	1500	-
X70 FL90 	4÷7	1.0	M5	CuZn-Sn	16.08415	-	3000	-

NEW

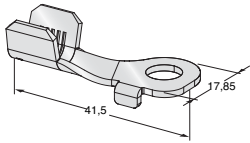
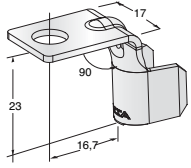
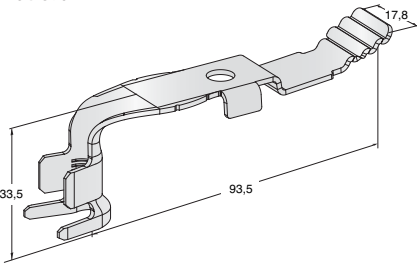
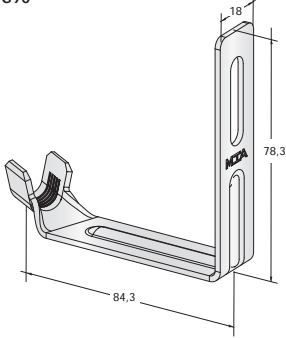
DISEGNO DRAWING DESSIN ZEICHNUNG	SEZIONE CAVO CABLE SECTION SECTION DU CÂBLE KABEL QUERSCHNITT mm ²	SPESSORE THICKNESS ÉPAISSEUR DICKE mm	VITE SCREW VIS SCHRAUBE	MATERIALE MATERIAL MATÉRIEL WERKSTOFF	REF.		PCS	MASTER PCS
					SCATOLA BOX BOÎTE SCHACHTEL	BOBINA REEL BOBINE SPULE		
STARTER L41 	10÷20	1.5	M8	CuZn-Sn	17.08360	-	500	2000
	25÷40	1.5	M8	CuZn-Sn	17.08370	-	400	1600
NEW								
FDU G90 	25÷40	1.5	M8	CuZn-Sn	16.08380	-	1500	-
NEW								
W84 G90 	25÷41	1.5	M8	CuZn-Sn	16.09400	-	400	-
NEW								
SLOT G90 	25÷40	1.8	M8	CuZn-Sn	16.09500	-	300	-
NEW								

DISEGNO DRAWING DESSIN ZEICHNUNG	SEZIONE CAVO CABLE SECTION SECTION DU CÂBLE KABEL QUERSCHNITT mm ²	SPESSORE THICKNESS ÉPAISSEUR DICKE mm	VITE SCREW VIS SCHRAUBE	MATERIALE MATERIAL MATÉRIEL WERKSTOFF	REF.		PCS	MASTER PCS
					SCATOLA BOX BOÎTE SCHACHETEL	BOBINA REEL BOBINE SPULE		
	16	2	M6 M8	Cu-Sn	16.05000	-	50	500
					16.05100	-	50	500
	25	2	M8 M10	Cu-Sn	16.05010	-	50	500
					16.05110	-	50	500
	35	2	M8 M10	Cu-Sn	16.05021	-	50	500
					16.05020	-	50	500
	50	2	M11	Cu-Sn	16.05030	-	25	250
	75	2	M13	Cu-Sn	16.05040	-	25	250

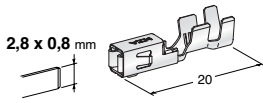
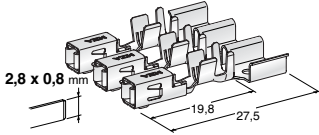
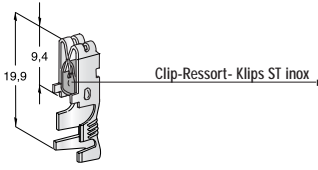
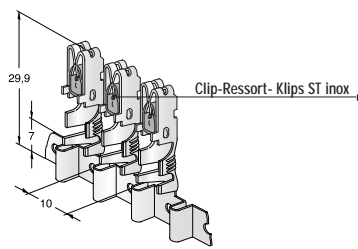
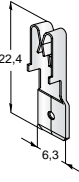

DISEGNO DRAWING DESSIN ZEICHNUNG	SEZIONE CAVO CABLE SECTION SECTION DU CÂBLE KABEL QUERSCHNITT mm ²	SPESSORE THICKNESS EPAISSEUR DICKE mm	MATERIALE MATERIAL MATERIEL WERKSTOFF	REF.		PCS	MASTER PCS
				SCATOLA BOX BOÎTE SCHACHTEL	BOBINA REEL BOBINE SPULE		
F800 	1.5÷2.5	0.5	CuZn-Sn	11.07650 -	- 17.07650	20 1000	- 6000
	4÷6	0.5	CuZn-Sn	11.07660 -	- 17.07660	20 1000	- 6000
	8÷10	0.5	CuZn-Sn CuNi-Sn	11.07670 - -	- 17.07670 17.07672	20 650 650	- 3900 3900
	16	0.5	CuNi-Sn	11.07671 -	- 17.07671	20 650	- 3900
M800 	2.5÷4	0.8	Cu-Sn	11.07675 -	- 17.07675	20 1000	- 4000
	6÷8	0.8	Cu-Sn	11.07685 -	- 17.07685	20 800	- 3200
	10÷16	0.8	Cu-Sn	11.07690 -	- 17.07690	20 650	- 2600
WP M800 	2.5÷4	0.8	Cu-Sn	11.07700 -	- 17.07700	20 1000	- 4000
	6÷8	0.8	Cu-Sn	11.07710 -	- 17.07710	20 800	- 3200
	10÷16	0.8	Cu-Sn	11.07720 -	- 17.07720	20 700	- 2800
F950 	2.5÷4	0.6	Cu-Sn	11.07740 -	- 17.07740	20 1000	- 4000
	6÷8	0.6	Cu-Sn	11.07741 -	- 17.07741	20 800	- 3200

DISEGNO DRAWING DESSIN ZEICHNUNG	SEZIONE CAVO CABLE SECTION SECTION DU CÂBLE KABEL QUERSCHNITT mm ²	SPESSORE THICKNESS EPAISSEUR DICKE mm	MATERIALE MATERIAL MATERIEL WERKSTOFF	REF.		PCS	MASTER PCS
				SCATOLA BOX BOÎTE SCHACHTEL	BOBINA REEL BOBINE SPULE		
WP M800 W/SEAL 	2.5÷4	0.8	Cu-Sn	-	17.07760	650	2600
	6÷8	0.8	Cu-Sn	-	17.07770	650	2600
	10÷16	0.8	Cu-Sn	-	17.07780	650	2600
WP F800 W/SEAL 	1.5÷2.5	0.5	CuZn-Sn	-	17.07400	650	3900
	3÷6	0.5	CuZn-Sn	-	17.07410	650	3900
	7÷10	0.5	CuNi-Sn	-	17.07420	650	3900
NEW 	3.4÷4.33	-	-	45.50781	-	5000	-
NEW 	4.9÷5.7	-	-	45.50782	-	5000	-
NEW TAPPO CHIUSURA CAVITY PLUG BOUCHON BLINDSTOPPEN 	-	-	-	45.50784	-	5000	-

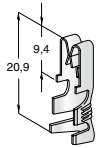
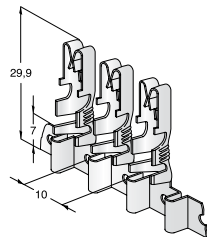
DISEGNO DRAWING DESSIN ZEICHNUNG	SEZIONE CAVO CABLE SECTION SECTION DU CÂBLE KABEL QUERSCHNITT mm ²	SPESSORE THICKNESS ÉPAISSEUR DICKE mm	MATERIALE MATERIAL MATÉRIEL WERKSTOFF	REF.		PCS	MASTER PCS
				SCATOLA BOX BOÎTE SCHACHTEL	BOBINA REEL BOBINE SPULE		
MINI F280 	0.35÷0.75	0.30	CuFe-Sn	11.08330 -	- 17.08330	100 3000	- -
	1÷2	0.30	CuFe-Sn	11.08331 -	- 17.08331	100 3000	- -
	2.5÷4	0.30	CuFe-Sn	11.08332 -	- 17.08332	100 3000	- -
MINI F280 BUS-BAR 	1÷2	0.30	CuFe-Sn	-	17.08335	5000	-
	2.5÷4	0.30	CuFe-Sn	-	17.08336	5000	-
UNI F630 C/CLIP 	0.5÷1.5	0.4	CuSn-Sn	11.07920 -	- 17.07920	100 2000	- 14000
	2÷3	0.4	CuSn-Sn	11.07930 -	- 17.07930	100 2000	- 14000
	4÷6	0.4	CuNi-Sn	11.07940 -	- 17.07940	50 1800	- 12600
UNI F630 BUS-BAR C/CLIP 	2÷3	0.4	CuSn-Sn	-	17.07932	3000	15000
	4÷6	0.4	CuNi-Sn	-	17.07942	3000	15000
UNI F630 	-	0.4	CuSn-Sn	11.07501 19.07501	- -	100 5000	- -

DISEGNO DRAWING DESSIN ZEICHNUNG	SEZIONE CAVO CABLE SECTION SECTION DU CÂBLE KABEL QUERSCHNITT mm ²	SPESSORE THICKNESS ÉPAISSEUR DICKE mm	MATERIALE MATERIAL MATERIEL WERKSTOFF	REF.		PCS	MASTER PCS
				SCATOLA BOX BOÎTE SCHACHTEL	BOBINA REEL BOBINE SPULE		
UNI F630 	0.5÷1.5	0.4	CuSn-Sn	11.07900 -	- 17.07900	100 2000	1000 10000
	2÷3	0.4	CuSn-Sn	-	17.07902	2000	10000
	4÷6	0.4	CuSn-Sn	11.07901 -	- 17.07901	100 1800	1000 9000
UNI F630 BUS-BAR 	0.5÷1.5	0.4	CuSn-Sn	-	17.07910	3000	15000
	2÷3	0.4	CuSn-Sn	-	17.07912	3000	15000
	4÷6	0.4	CuSn-Sn	-	17.07911	3000	9000

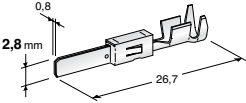
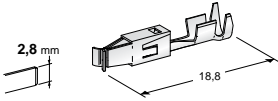
DISEGNO DRAWING DESSIN ZEICHNUNG	SEZIONE CAVO CABLE SECTION SECTION DU CÂBLE KABEL QUERSCHNITT mm ²	SPESSORE THICKNESS EPAISSEUR DICKE mm	MATERIALE MATERIAL MATERIEL WERKSTOFF	REF.		PCS	MASTER PCS
				SCATOLA BOX BOÎTE SCHACHTEL	BOBINA REEL BOBINE SPULE		
METRIPACK M150 	0.5÷1	0.4	CuSn-Sn	11.05510	-	100	-
METRIPACK F150 	0.5÷1	0.4	CuSn-Sn	11.05500 -	- 17.05500	100 4000	- -
	0.5÷1	-	Silicon	44.07530 45.07530	- -	100 5000	- -
S-SEAL M150 	1÷1.5	0.32	CuZn-Sn	11.05550 -	- 17.05550	100 4000	- -
S-SEAL F150 	1÷1.5	0.3	CuSn-Sn	11.05560 -	- 17.05560	100 3500	- -
	0.5÷1	-	Silicon	44.07740 45.07740	- -	100 10000	- -
TAPPO CHIUSURA CAVITY PLUG BOUCHON BLINDSTOPPEN 	-	-	Silicon	44.07750	-	100	-
METRIPACK M280 	1÷2.5	0.4	CuSn-Sn	11.04500 -	- 17.04500	50 3500	- -
METRIPACK F280 	1÷2.5	0.4	CuSn-Sn	11.04510 -	- 17.04510	100 3200	- -
	1÷2.5	-	Silicon	44.07510 45.07510	- -	100 5000	- -
070DTB M280 	1÷1.5	0.4	CuZn-Sn	11.08420	-	100	-
070DTB F280 	1÷1.5	0.4	CuZn-Sn	11.08410	-	100	-

DISEGNO DRAWING DESSIN ZEICHNUNG	SEZIONE CAVO CABLE SECTION SECTION DU CÂBLE KABEL QUERSCHNITT mm ²	SPESSORE THICKNESS EPAISSEUR DICKE mm	MATERIALE MATERIAL MATERIEL WERKSTOFF	REF.		PCS	MASTER PCS
				SCATOLA BOX BOÎTE SCHACHTEL	BOBINA REEL BOBINE SPULE		
JPT-WP M280 	0.5÷1.5	0.32	CuSn-Sn	11.08290	-	100	-
	1.5÷2.5	0.32	CuSn-Sn	11.08300	-	100	-
JPT-WP F280 	0.5÷1	0.32	CuSn-Sn	11.08260	-	100	-
	1÷2.5	0.32	CuSn-Sn	11.08270	-	100	-
	0.5÷1	-	Silicon	45.10662	-	100	-
	1.5÷2.5	-	Silicon	44.10658 45.10658	- -	10 100	- -

DISEGNO DRAWING DESSIN ZEICHNUNG	SEZIONE CAVO CABLE SECTION SECTION DU CÂBLE KABEL QUERSCHNITT mm ²	SPESSORE THICKNESS EPAISSEUR DICKE mm	MATERIALE MATERIAL MATERIEL WERKSTOFF	REF.		PCS	MASTER PCS
				SCATOLA BOX BOÎTE SCHACHTEL	BOBINA REEL BOBINE SPULE		
CARALARM F150 	0.75÷1.5	0.30	CuZn-Sn	11.05650 -	- 17.05650	100 4500	- -
JT M280 	0.35÷1	0.32	CuZn-Sn	11.08280	-	100	-
JT F280 	0.5÷1.5	0.32	CuZn-Sn	11.07210	-	200	-
	1.5÷2.5	0.32	CuZn-Sn	11.07211	-	100	-
MARKII M280 	0.5÷1.5	0.4	CuZn-Sn	11.02010	-	200	-
MARKII F280 Per fanali posteriori For tail lamps Pour lanternes arrieres Für Rücklichter 	0.5÷1.5	0.4	CuZn-Sn	11.02000	-	200	-
M280 	0.5÷1	0.3	CuFe-Sn	11.08030	-	50	-
F280 	0.5÷1	0.3	CuFe-Sn	11.08050	-	100	-
DIN 46343 Universale per autoradio Universal for car radio Universel pour autoradio Universal für autoradio 	0.5÷1	0.38	CuSn-Sn	11.08060	-	100	-
JPT F280 	0.2÷0.5	0.32	CuSn-Sn	11.05615	-	100	-
	0.5÷1	0.32	CuSn-Sn	11.05620	-	100	-
	1.5÷2.5	0.32	CuSn-Sn	11.05630	-	100	-

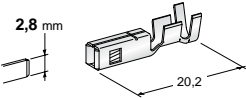
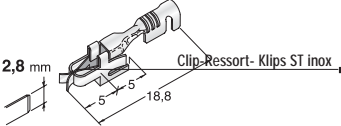
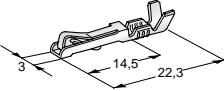
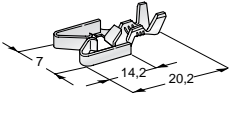
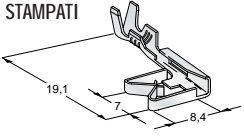
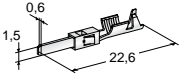
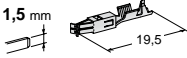
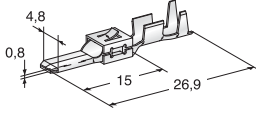
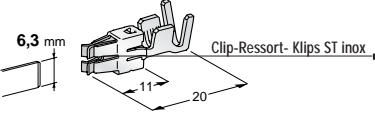
DISEGNO DRAWING DESSIN ZEICHNUNG	SEZIONE CAVO CABLE SECTION SECTION DU CÂBLE KABEL QUERSCHNITT mm ²	SPESSORE THICKNESS ÉPAISSEUR DICKE mm	MATERIALE MATERIAL MATÉRIEL WERKSTOFF	REF.		PCS	MASTER PCS
				SCATOLA BOX BOÎTE SCHACHETEL	BOBINA REEL BOBINE SPULE		
SICMA2 F280 	0.35÷0.75	0.35	CuZn-Sn	11.05660	-	100	-
	1÷2.5	0.35	CuZn-Sn	11.05670	-	100	-
JPT F280 	0.5÷1	0.4	CuSn-Sn	11.07209	-	100	-
	1.5÷2.5	0.4	CuSn-Sn	11.07212	-	100	-
FANALI POST. VW-FIAT  <p>For tail lamps Pour lanternes arrières Für Rücklichter</p>	0.35÷1	0.3	CuZn-Sn	11.01800	-	200	-
FANALI POST. C/CIRCUITI STAMPATI  <p>For tail lamps Pour lanternes arrières Für Rücklichter</p>	1÷2.5	0.3	CuZn-Sn	11.01920	-	100	-
CRUSCOTTO C/CIRCUITI STAMPATI  <p>For dashboard Pour tableau de bord Für Armaturenbrett</p>	0.5÷1.5	0.3	CuSn-Sn	11.01930	-	100	-
MFS M150 	0.5÷1	0.3	CuFe-Sn	11.08010	-	100	-
MKF F150 	0.5÷1	0.3	CuFe-Sn	11.08020	-	100	-
M480 	1.5÷2.5	0.38	CuFe-Sn	11.08040	-	50	-
SPT F630 	2.5÷4	0.4	CuSn-Sn	11.02050	-	100	-

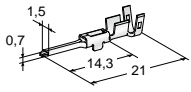
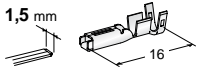
DISEGNO DRAWING DESSIN ZEICHNUNG	SEZIONE CAVO CABLE SECTION SECTION DU CÂBLE KABEL QUERSCHNITT mm ²	SPESSORE THICKNESS EPAISSEUR DICKE mm	MATERIALE MATERIAL MATERIEL WERKSTOFF	REF.		PCS	MASTER PCS
				SCATOLA BOX BOÎTE SCHACHTEL	BOBINA REEL BOBINE SPULE		
070 M150 	0.75÷1.5	0.3	CuZn-Sn	11.08080	-	100	-
070 F150 	0.3÷0.5	0.32	CuZn-Sn	11.07260	-	100	-
	0.75÷1.5	0.32	CuZn-Sn	11.08070	-	100	-

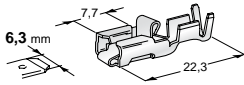
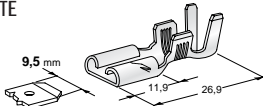
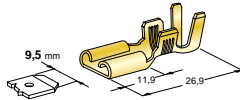
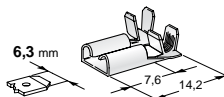
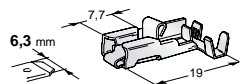
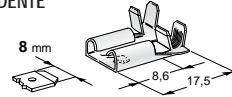
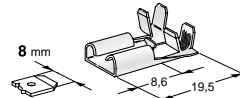
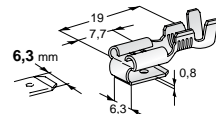
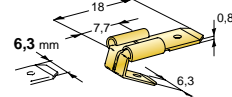
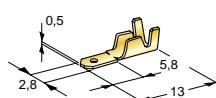
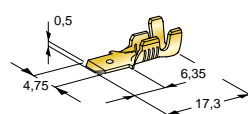

DISEGNO DRAWING DESSIN ZEICHNUNG	SEZIONE CAVO CABLE SECTION SECTION DU CÂBLE KABEL QUERSCHNITT mm ²	SPESSORE THICKNESS EPAISSEUR DICKE mm	MATERIALE MATERIAL MATERIEL WERKSTOFF	REF.		PCS	MASTER PCS
				SCATOLA BOX BOÎTE SCHACHTEL	BOBINA REEL BOBINE SPULE		
PASSO 5 F480 	0.5÷1.5	0.28	CuZn	13.01910 -	- 14.01910	100 5000	- -
PASSO 5 F480 	0.5÷1.5	0.35	CuZn-Sn	11.01940 -	- 17.01940	100 12000	- -
PASSO 5 F480 	0.5÷1.5	0.4	CuSn-Sn	11.01970	-	100	-
PASSO 5 M480 C/DENTE 	0.5÷1.5	0.4	CuZn-Sn	11.01950	-	100	-

DISEGNO DRAWING DESSIN ZEICHNUNG	SEZIONE CAVO CABLE SECTION SECTION DU CÂBLE KABEL QUERSCHNITT mm ²	SPESSORE THICKNESS EPAISSEUR DICKE mm	MATERIALE MATERIEL MATERIEL WERKSTOFF	REF.		PCS	MASTER PCS
				SCATOLA BOX BOÎTE SCHACHTEL	BOBINA REEL BOBINE SPULE		
FASTON F280 C/DENTE 	0.5÷1	0.25	CuZn-Sn	11.01700	-	200	-
FASTON F280 	0.5÷1	0.3	CuZn CuZn CuZn-Sn	13.01390 19.01390 -	- - 17.01390	200 10000 10000	2000 - -
FASTON F480 C/DENTE 	0.5÷1	0.32	CuZn-Sn	11.01710	-	100	-
FASTON F480 	0.5÷1	0.33	CuZn CuZn CuZn-Sn	13.01391 19.01391 -	- - 17.01391	100 10000 10000	- - -
ANTISF F480 	0.35÷1	0.4	CuZn-Sn	11.07030	-	100	-
FASTON F630 C/DENTE 	1÷2.5	0.35	CuZn-Sn CuZn CuZn CuZn-Sn CuZn-Sn	11.01650 13.01650 19.01650 - 19.11650	- - - 17.01650 -	100 100 5000 5000 5000	5000 5000 - - -
	2.5÷6	0.35	CuZn-Sn	-	17.01651	3000	-
FASTON F630 	0.3÷0.8	0.4	CuZn CuZn CuZn	13.01402 19.01402 -	- - 14.01402	100 5000 5000	- - -
	1÷2.5	0.35	CuZn-Sn	-	17.01655	5000	-
	1÷2.5	0.4	CuZn-Sn CuZn CuZn CuZn CuZn-Sn CuZn-Sn	11.01400 13.01400 19.01400 - - 19.11400	- - - 14.01400 17.01400 -	200 200 5000 5000 5000 5000	10000 10000 - - - -





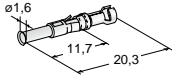
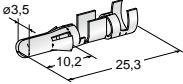

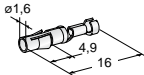







DISEGNO DRAWING DESSIN ZEICHNUNG	SEZIONE CAVO CABLE SECTION SECTION DU CÂBLE KABEL QUERSCHNITT mm ²	SPESSORE THICKNESS ÉPAISSEUR DICKE mm	MATERIALE MATERIAL MATÉRIEL WERKSTOFF	REF.		PCS	MASTER PCS
				SCATOLA BOX BOÎTE SCHACHETEL	BOBINA REEL BOBINE SPULE		
ANTISF F630 	0.5÷1.5	0.4	CuZn-Sn	11.07000 -	- 17.07000	50 1500	- -
	2.5÷4	0.4	CuZn-Sn	11.07010	-	50	-
FASTON F950 C/DENTE 	6÷10	0.4	CuZn-Sn	11.01720	-	100	-
FASTON F950 	2÷4	0.5	CuZn	13.01420 19.01420	- -	100 5000	- -
FASTON F630 FLAG 	0.5÷1.5	0.4	CuZn-Sn	-	17.01530	4000	-
ANTISF F630 FLAG 	1÷2.5	0.4	CuZn-Sn	11.07020	-	50	-
FASTON F800 FLAG C/DENTE 	1÷2.5	0.4	CuZn-Sn	11.01680	-	50	-
FASTON F800 FLAG 	1÷2.5	0.4	CuZn-Sn	19.51145	-	1000	-
FASTON 630 2VIE 	0.8÷2.5	0.4	CuZn-Sn	13.01501 19.01501	- -	100 5000	- -
FASTON 630 3VIE 	-	0.4	CuZn	13.01500 19.01500	- -	100 5000	- -
FASTON M280 	0.5÷1	0.5	CuZn	13.01418 19.01418	- -	200 5000	- -
FASTON M480 	0.5÷1	0.5	CuZn	13.01417 19.01417	- -	200 5000	- -

DISEGNO DRAWING DESSIN ZEICHNUNG	SEZIONE CAVO CABLE SECTION SECTION DU CÂBLE KABEL QUERSCHNITT mm ²	SPESSORE THICKNESS EPAISSEUR DICKE mm	MATERIALE MATERIAL MATERIEL WERKSTOFF	REF.		PCS	MASTER PCS
				SCATOLA BOX BOÎTE SCHACHTEL	BOBINA REEL BOBINE SPULE		
FASTON M630 C/DENTE 	1÷2.5	0.4	CuZn-Sn	11.01660	-	100	-
			CuZn	13.01660	-	100	5000
CuZn			19.01660	-	5000	-	
CuZn			-	14.01660	4000	-	
CuZn-Sn			-	17.01660	4000	-	
	4÷6	0.4	CuZn-Sn	11.01662	-	100	1000
FASTON M630 C/DENTE 	1÷2.5	0.4	CuZn	13.01665	-	100	-
				19.01665	-	5000	-
FASTON M630 	0.5÷1	0.4	CuZn	13.01411	-	100	-
				19.01411	-	5000	-
-				14.01411	5000	-	
	1÷2.5	0.4	CuZn	13.01412	-	100	5000
CuZn			19.01412	-	5000	-	
CuZn-Sn			11.01412	-	100	5000	
CuZn-Sn			-	17.01412	5000	-	
CuZn-Sn			19.51194	-	5000	-	

DISEGNO DRAWING DESSIN ZEICHNUNG	SEZIONE CAVO CABLE SECTION SECTION DU CÂBLE KABEL QUERSCHNITT mm ²	SPESSORE THICKNESS EPAISSEUR DICKE mm	MATERIALE MATERIEL WERKSTOFF	REF.		PCS	MASTER PCS
				SCATOLA BOX BOÎTE SCHACHTEL	BOBINA REEL BOBINE SPULE		
L13 M4 	1÷2.5	0.4	CuZn	12.01000	-	100	1000
L17 F4 	1÷2.5	0.4	CuZn	12.01070	-	100	1000
L24 F4 	0.5÷2.5	0.4	CuZn CuZn-Sn	12.01100 -	- 17.01100	100 4000	- -
L21 F4 	0.5÷2.5	0.4	CuZn CuZn-Sn	12.01110 -	- 17.01110	100 4000	- -
MATE-N-LOCK M2 	0.5÷2.5	0.3	CuZn-Sn	12.01210	-	200	-
MATE-N-LOCK F2 	0.5÷2.5	0.3	CuZn-Sn	12.01200	-	200	-
ECONOSEAL M1.5 	0.5÷1.5	0.3	CuZn-Sn	12.01230	-	200	-
ECONOSEAL F1.5 	0.5÷1.5	0.3	CuZn-Sn	12.01220	-	200	-
L20 M2.1 Per temperatura acqua For water temperature Pour température de l'eau Für Wassertemperaturen	0.5÷1	0.32	CuZn-Sn	12.01150	-	200	-
L17 F2 	0.5÷1	0.32	CuZn-Sn	12.01160	-	200	-
L17 F2.15 Per connettori passo 3.2 For connectors pitch 3.2 Pour connecteurs pas 3.2 Für Mehrfachsteckgehäuse Abstand 3.2	0.3÷0.5	0.125	CuBe-Sn	12.01180	-	200	-
L29 M1.6 	0.5÷1	0.35	CuSn-Sn	11.07960	-	100	-

DISEGNO DRAWING DESSIN ZEICHNUNG	SEZIONE CAVO CABLE SECTION SECTION DU CÂBLE KABEL QUERSCHNITT mm ²	SPESSORE THICKNESS EPAISSEUR DICKE mm	MATERIALE MATERIAL MATERIEL WERKSTOFF	REF.		PCS	MASTER PCS
				SCATOLA BOX BOÎTE SCHACHTEL	BOBINA REEL BOBINE SPULE		
L20 F1.6 	0.5÷1	0.35	CuSn-Sn	11.07970	-	100	-
L25 M3.5 	2.5÷6	0.35	CuSn-Sn	11.07980	-	50	-
	1÷2.5	0.35	CuSn-Sn	11.07990	-	50	-
L20 F3.5 	2.5÷6	0.35	CuSn-Sn	11.08000	-	50	-
L16 F1.6 	0.3÷0.6	0.3	CuZn-Sn	11.08100	-	100	-

DISEGNO DRAWING DESSIN ZEICHNUNG	DESCRIZIONE DESCRIPTION DESCRIPTION BESCHREIBUNG	SEZIONE CAVO CABLE SECTION SECTION DU CÂBLE KABEL QUERSCHNITT mm ²	SPESSORE THICKNESS ÉPAISSEUR DICKE mm	MATERIALE MATERIAL MATÉRIEL WERKSTOFF	REF.		PCS	MASTER PCS
					SCATOLA BOX BOÎTE SCHACHTEL	BOBINA REEL BOBINE SPULE		
	Attacco candela con clip Plug terminal with clip Cosse de bougie avec ressort Kerzenstecker mit Klips	7	0.5	St AISI 430	-	14.00860	2000	-
	Attacco candela con clip e dentino Plug terminal with clip and locking notch Cosse de bougie avec ressort et griffe antiéfillage Kerzenstecker mit Klips und Rastnase	7	0.5	St AISI 430	-	14.00865	2000	-
	Attacco candela con clip a doppio aggraffaggio Plug terminal with double crimping clip Cosse de bougie avec ressort double sertissage Kerzenstecker mit Klips	7	0.5	St AISI 430	-	14.00850	2000	-
	Attacco candela 90° con clip Plug terminal 90° with clip Cosse de bougie 90° avec ressort Kerzenstecker 90° mit Klips	7	0.5	St AISI 430	-	14.00862	1000	4000
	Attacco bobina - distributore 90° Coil - distributor 90° Bobine - distributeur 90° Spule - Verteiler 90°	7	0.5	CuZn 67	12.00880 -	- 14.00880	100 1000	- 4000
	Attacco bobina - distributore Coil - distributor Bobine - distributeur Spule - Verteiler	7	0.5	CuZn 67	-	14.00910	2500	-
	Attacco bobina - distributore Coil - distributor Bobine - distributeur Spule - Verteiler	7	0.5	CuZn 67	-	14.00920	2500	-
	Attacco bobina - distributore Coil - distributor Bobine - distributeur Spule - Verteiler	7	0.5	CuZn 67	19.00830	-	5000	-
	Attacco bobina - distributore Coil - distributor Bobine - distributeur Spule - Verteiler	7	0.5	CuZn 67	12.00831 19.00831	- -	100 5000	-

DISEGNO DRAWING DESSIN ZEICHNUNG	DESCRIZIONE KIT KIT DESCRIPTION KIT DESCRIPTION KIT BESCHREIBUNG			REF.	PCS
		MALE 6.3 mm	20 PCS	16.06940	1
		FEMALE 6.3 mm	20 PCS		
		TERMINAL COVER	10 PCS		
		TERMINAL COVER	10 PCS		
		TERMINAL COVER	10 PCS		
		TERMINAL COVER	10 PCS		
		MALE 6.3 mm	15 PCS	16.06950	1
		FEMALE 6.3 mm	15 PCS		
		ø 4.3 ø 5.4 ø 6.4 ø 8.4	15 PCS 15 PCS 15 PCS 15 PCS		
		FEMALE 6.3 mm	10 PCS	16.07000	1
		TERMINAL COVER	5 PCS		
		TERMINAL COVER	5 PCS		

DISEGNO DRAWING DESSIN ZEICHNUNG	DESCRIZIONE KIT KIT DESCRIPTION KIT DESCRIPTION KIT BESCHREIBUNG			REF.	PCS
<p>153 mm</p> <p>213 mm</p> <p>41 mm</p>		FEMALE 2.8 mm	100 PCS	16.06820	1
		FEMALE 4.7 mm	100 PCS		
		MALE 4.7 mm	100 PCS		
		FEMALE 6.3 mm	50 PCS		
		MALE 6.3 mm	50 PCS		
		FEMALE 9.5 mm	25 PCS		
		PIGGY BACK	20 PCS		
		MALE 6.3 mm	50 PCS		
		FEMALE 6.3 mm	50 PCS		
		ø 4.3 ø 5.4 ø 6.4	50 PCS 50 PCS 30 PCS		
		TERMINAL COVER	20 PCS		
		TERMINAL COVER	30 PCS		
		TERMINAL COVER	30 PCS		